

MP3 PLAYER KIT

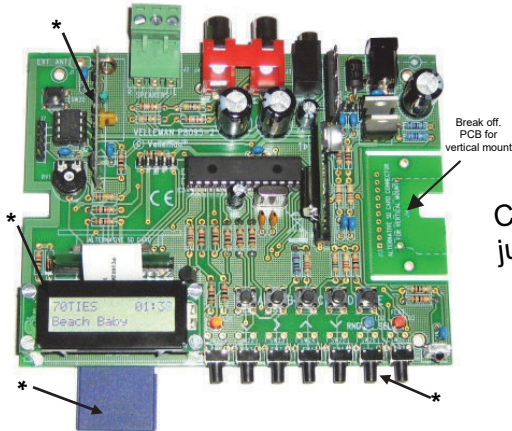

* In the picture is shown:

- Optional LCD type PC1602WRS-KWA-E
- Some horizontal type push buttons type PS-04PV
- RF receiver modules type RX433N
- SD card (not included)

K8095

Create your own home audio system,
 juke box, jingle player, sound effects, ...

Optional:



VM160DT



VM118R / K8058



VM160T



PS1210



RX433N

Features

- SD card operation
- high-quality VLSI decoder
- 5 Preset folder access buttons
- play-pause, next, previous, search
- volume control
- random and shuffle
- 8 different preset sound modes
- 6 play modes: All, Folder, At power-on...
- infrared receiver
- on-board power amplifier
- RCA pre out
- headphone and speaker outputs
- mono operation is possible
- vertical or horizontal SD position possible
- suits commercially available LCD types

Specifications

- suitable for SD and SDHC cards
- tested up to 32GB cards
- supports ID3 TAG information: Title, Artist Name, Album Name and Year are displayed on the (optional) 2-line 16 char. LCD
- supports folders to one level deep
- up to 1024 folders, each containing up to 16384 songs
- equalizer settings: Flat , Loudness, Heavy, Clear, Soft, Disco, Live and Hall
- decodes MP3 (MPEG 1.0 & 2.0 audio layer III (CBR, VBR, ABR), till 320kbit/s. Fraunhofer IIS and Thomson licensed
- amplifier: 2x 5Wrms @ 4ohm
- power supply: 12Vdc/1A

Optional:

- LCD: [PC1602WRS-KWA-E](#)
- RF receiver module: [RX433N](#)
- power adaptor: [PS1210](#)
- RF remotes: for EU and US
 - 8-channel RF remote transmitter: [VM118R](#) (assembled) / [K8058](#) (Kit-version)
- RF remotes: only for EU:
 - 4-channel desktop transmitter: [VM160DT](#)
 - 4-channel transmitter: [VM160T](#)
- IR remotes: 15-channel IR transmitter: [K8049](#) (Kit-version)

1. Assembly (Skipping this can lead to troubles !)

Ok, so we have your attention. These hints will help you to make this project successful. Read them carefully.

1.1 Make sure you have the right tools:

- A good quality soldering iron (25-40W) with a small tip.
- Wipe it often on a wet sponge or cloth, to keep it clean; then apply solder to the tip, to give it a wet look. This is called 'thinning' and will protect the tip, and enables you to make good connections. When solder rolls off the tip, it needs cleaning.
- Thin raisin-core solder. Do not use any flux or grease.
- A diagonal cutter to trim excess wires. To avoid injury when cutting excess leads, hold the lead so they cannot fly towards the eyes.
- Needle nose pliers, for bending leads, or to hold components in place.
- Small blade and Phillips screwdrivers. A basic range is fine.

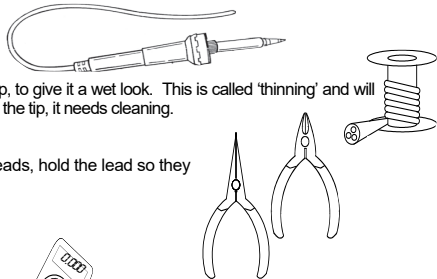

For some projects, a basic multi-meter is required, or might be handy



1.2 Assembly Hints :

- ⇒ Make sure the skill level matches your experience, to avoid disappointments.
 - ⇒ Follow the instructions carefully. Read and understand the entire step before you perform each operation.
 - ⇒ Perform the assembly in the correct order as stated in this manual
 - ⇒ Position all parts on the PCB (Printed Circuit Board) as shown on the drawings.
 - ⇒ Values on the circuit diagram are subject to changes.
 - ⇒ Values in this assembly guide are correct*
 - ⇒ Use the check-boxes to mark your progress.
 - ⇒ Please read the included information on safety and customer service
- * Typographical inaccuracies excluded. Always look for possible last minute manual updates, indicated as 'NOTE' on a separate leaflet.

1.3 Soldering Hints :

1- Mount the component against the PCB surface and carefully solder the leads

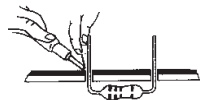

2- Make sure the solder joints are cone-shaped and shiny

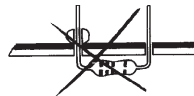
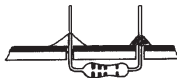

3- Trim excess leads as close as possible to the solder joint



REMOVE THEM FROM THE TAPE ONE AT A TIME !

DO NOT BLINDLY FOLLOW THE ORDER OF THE COMPONENTS ONTO THE TAPE. ALWAYS CHECK THEIR VALUE ON THE PARTS LIST!

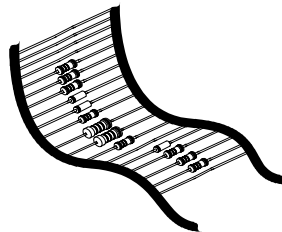

IMPORTANT!

Thanks a lot for buying this MP3 player project.

For your convenience, the MP3 decoder circuit is pre assembled on a plug-in board. This kit allows you to create a full customized MP3 player, build completely to you wishes.

Standard only infrared receiver is included to work with our K8049 but an optional RF receiver can be mounted, for use with our transmitters VM118R - K8058 or remotes VM160T or VM160DT (DeskTop version).

The board can be used vertically or horizontally. For vertical mount , a sub board for the SD card holder is provided. There can be mounted several types of buttons (standard all small vertical types), optionally horizontal types can be used, or types with a longer actuator. The optional LCD uses a standard 4 bit nibble mode, so most 2 line 16 character LCD modules can be used.

Download the user manual on our web site (check the K8095 product page)

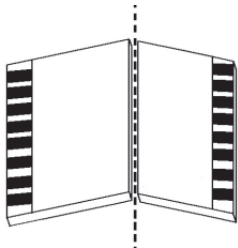
**CAUTION:**

This preassembled board contains an expensive MP3 decoder chip.
This board has been fully tested before shipping.
Treat this board with caution and mind static electricity.
Always touch an earthed metal part before handling this board.

This board contains the connector for an optional LCD, the connector must be broken off.
The board has a V-cut slot; carefully break off this part from the MP3 decoder board along the slot.

1. Horizontal resistors

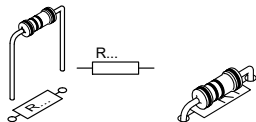

- R1 ... R8 : 47 (4-7-0-B)
- R9 ... R12 : 100 (1-0-1-B)
- R13, R14 : 180 (1-8-1-B)
- R15 : 220 (2-2-1-B)
- R16 : 560 (5-6-1-B)
- R17 : 680 (6-8-0-0-1)
- R18 ... R24 : 1K (1-0-2-B)
- R25, R26 : 1K1 (1-1-0-1-1)
- R27 : 2K4 (2-4-0-1-1)
- R28 ... R34 : 10K (1-0-3-B)
- R35 : 100K (1-0-4-B)

2. Diode. Watch the polarity!



- D1 : BAT85
- D2 : 1N5400

D2 not on tape!

3. IC socket. Watch the position of the notch!

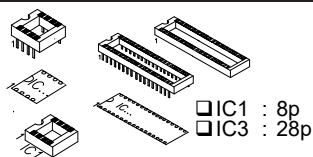

- IC1 : 8p
- IC3 : 28p

4. Trim potentiometer



- RV1 : 10K
Contrast

5. LED. Watch the polarity!

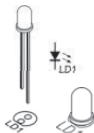

- LD1 : 3mm red
- LD2 : 3mm red
- LD3 : 3mm red
- LD4 : 3mm red*

* LD4 is not mounted if an optional LCD is used with backlight

6. Board-edge connector

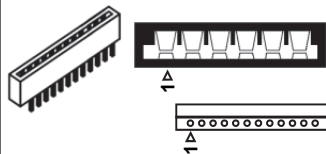

- J6 : MP3 decoder board
- J10 : LCD unit board

7. Push buttons

- | | | | |
|------------------------------|------------|-------------------------------|--------|
| <input type="checkbox"/> SW1 | Play/pause | <input type="checkbox"/> SW8 | A |
| <input type="checkbox"/> SW2 | Previous | <input type="checkbox"/> SW9 | B |
| <input type="checkbox"/> SW3 | Next | <input type="checkbox"/> SW10 | C |
| <input type="checkbox"/> SW4 | Up | <input type="checkbox"/> SW11 | D |
| <input type="checkbox"/> SW5 | Down | <input type="checkbox"/> SW12 | E |
| <input type="checkbox"/> SW6 | Select | <input type="checkbox"/> SW13 | remote |
| <input type="checkbox"/> SW7 | random | | |



Optional for SW1 ... SW7

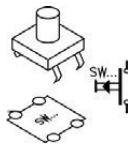

8. Capacitors.

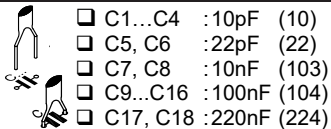

9. Male PCB connector

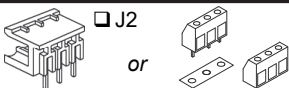

10. Transistors

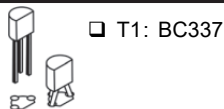

11. Pin header

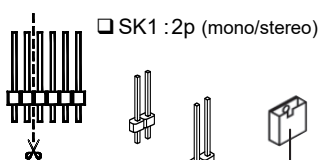

mounted = mono output

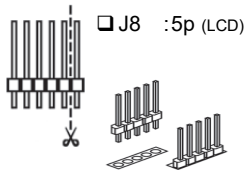

Mount a shunt if no LCD will be mounted.

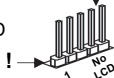

12. IR-demodulator

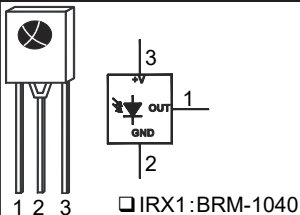

13. Crystal

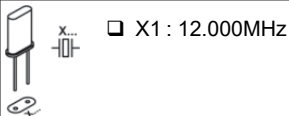

14. Connector

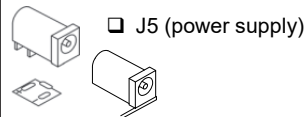

15. Electrolytic Capacitor. Watch the polarity !

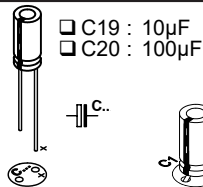

16. stereo phone jack

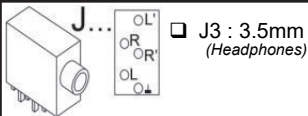

17. RCA connector



18. Stereo amplifier

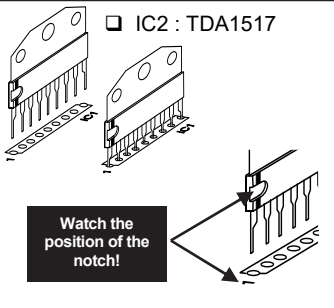

19. Electrolytic Capacitor. Watch the polarity !

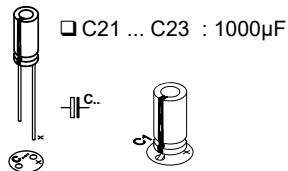

20. Voltage regulator

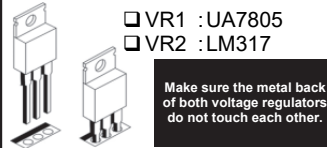

21. IC. Watch the position of the notch!

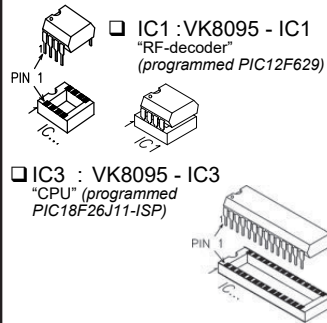

22. SD-card holder

The Sd-card holder can be mounted vertically and horizontally.

Horizontal position:

Mount the card-holder onto the solderside of the main pcb (fig. 1)

Vertical position:

1. Remove the alternative PCB, to be used for the vertical mounting of the SD card holder, from the main PCB (fig. 2).
2. Turn over the alternative PCB allowing you to mount the SD card holder (fig. 3).
3. Insert a pin into each connection and bend each one of those pins (fig. 4).
4. Mount the assembly onto the main PCB and solder the connections (fig. 5).

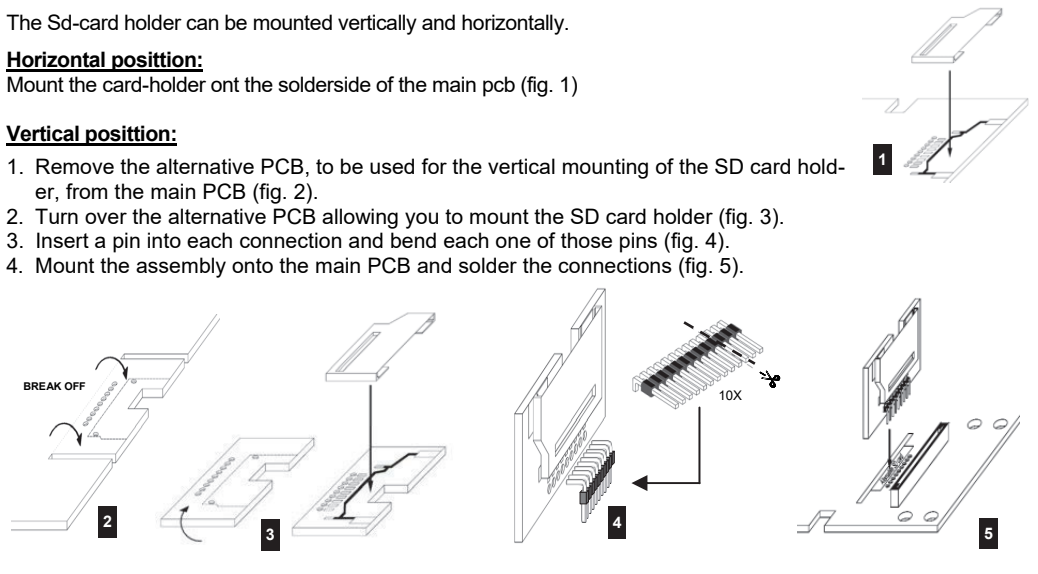

23. MP3 unit

Insert the pre-assembled and tested MP3 decoder.

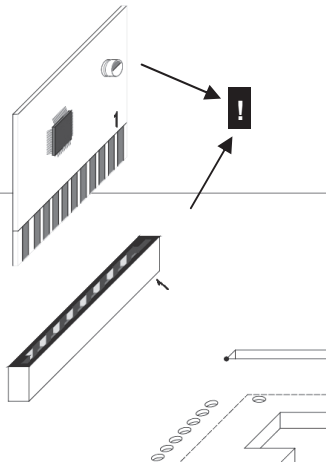

Pay attention to the mounting order of the MP3 unit !

24. Rubber feet

Mount the rubber feet on the solder side of the PCB.

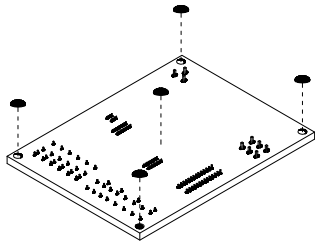

25. Optional

RF-receiver:

For RF remote use, mount an RX433 module. See picture on the box.

LCD-display:

If an LCD is used, mount the optional PCI602WRS-KWA-E LCD. Use the edge board to connect the LCD. See picture on the box.



The mounting procedure for the RF-receiver and LCD-display can be found on our website:

www.velleman.eu

26. Connection

Speakers

Connect a pair of speakers to the speaker connector.

Use 4 – 8 ohms speakers (L+ and R+) and connect the common (-) to the centre tab.

 **Hint:** If multiple speakers are used you can connect speakers in series + parallel.

Example:

- Use 4 x 8-ohm speakers.
- Connect 2 speaker sets in series ($8 + 8 = 16$ ohms).
- Then connect this set in parallel ($16/2 = 8$ ohms).
- Now these 4 speakers can be connected to the L or R output.

If you use multiple speakers for multi-room use, it is advised to use the unit with MONO output.

To do this, add a shunt over the MONO pin header.

RCA out

You can connect an optional power amplifier to this output.

Headphone out

You can connect a headphone to this output.

 **NOTE:** The volume of all the outputs is controlled by the player master volume.

SD card

Insert a suitable SD card containing MP3 files.

The MP3 files can be in the root of the SD card or in 1 folder deep.

If the standard board connector is used, insert the card with the connections facing upwards.

Power

Connect a suitable power supply to the 12VDC input (pin= +).

Make sure the supply can deliver 1A or more.

27. Test

If all is going well, the power LED should light, press the "play" button to start or pause the first song.

If an LCD is connected, the display should light and indicate:

"Hello" with the firmware version, followed by "Velleman MP3 player".

If no SD card is inserted, the display will indicate "No SD card".



Check the user manual for more instructions.

Download the manual from our site:

Enter "K8095" in the search option.

On the product page, go to the download section.

Schematic diagram "MP3 unit" + "main PCB"

MP3 unit

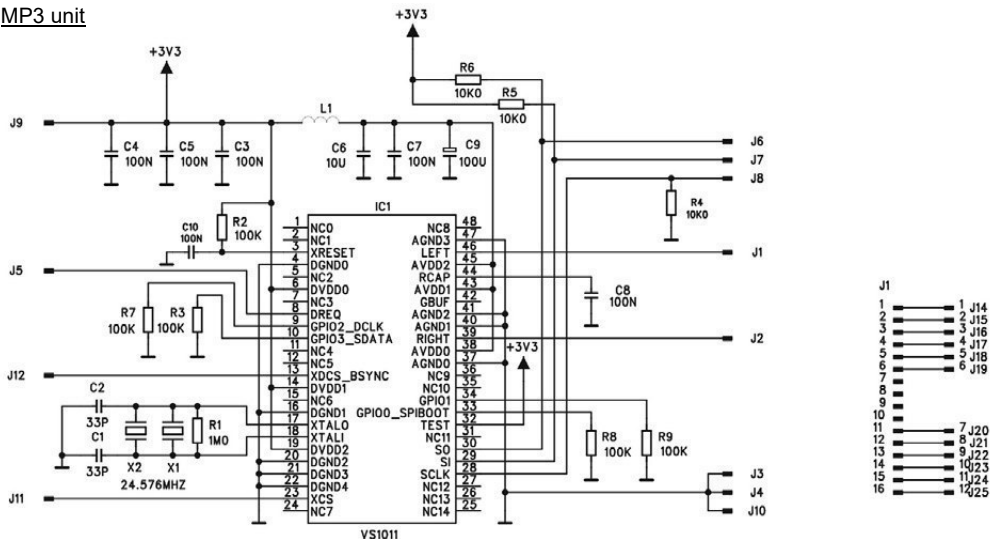

Main PCB

Main PCB

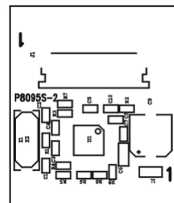
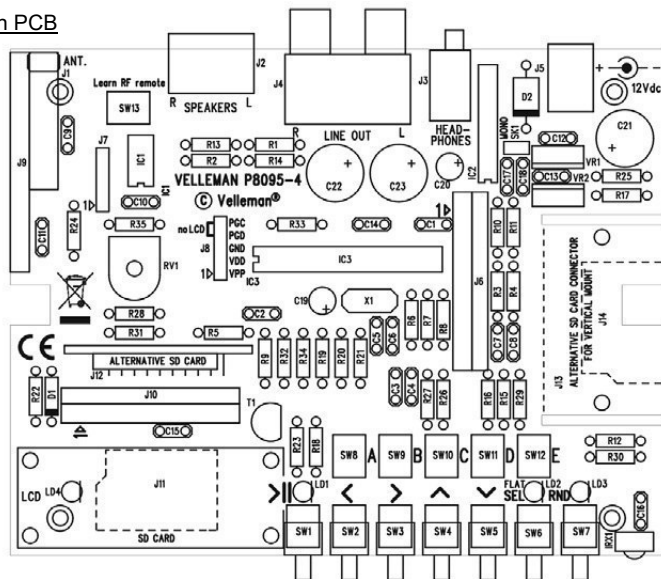

MP3 decoder

Main

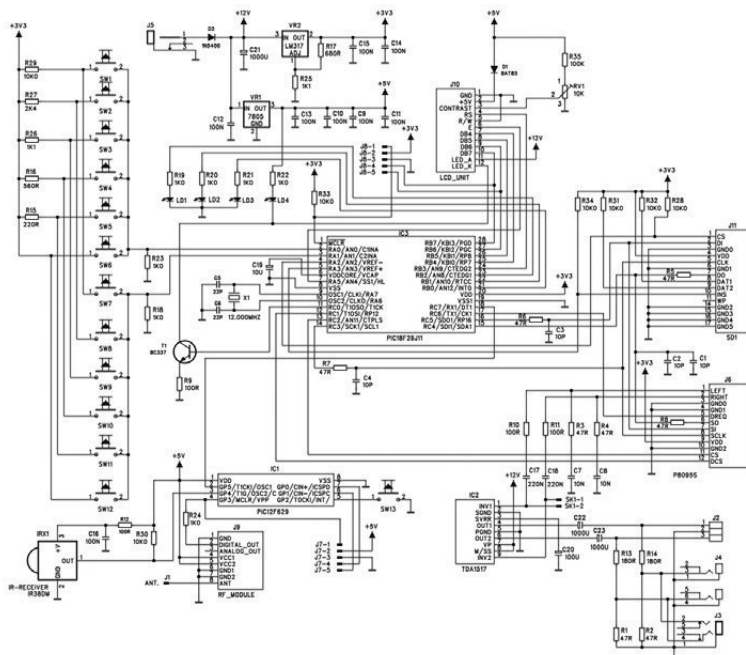

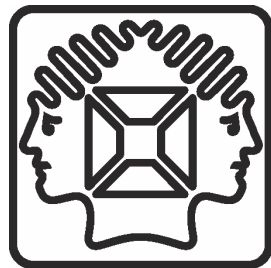

VELLEMAN NV
Legen Heirweg 33, B-9890 GAVERE
Belgium (Europe)

 @velleman_RnD

