

K8026

ILLUSTRATED ASSEMBLY MANUAL H8026IP'1

3.5A DIMMER WITH POTENTIOMETER



velleman®
projects

@velleman_RnD

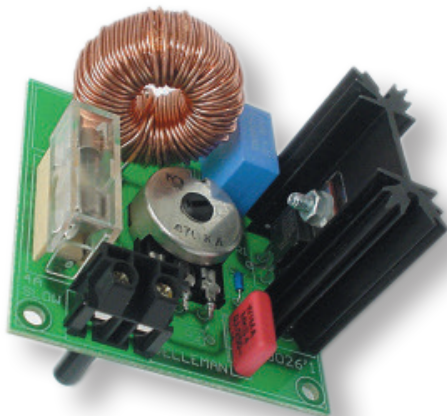

Due to its small size, this small dimmer easily replaces an existing switch, permitting you to vary the brightness of a light or group of lights. The dimmer may also be used to adjust the speed of a motor, vacuum cleaner, or any other motor with carbon brushes. A mains suppressor is provided eliminating undesirable RFI. It is not suitable for halogen lamps.

Specifications

- protected against induction voltage peaks
- Load: 3.5A (750W at 230V and 380W at 110V)
- suppressed according to EN55015
- PCB dimensions: 60 x 60mm / 2.4 x 2.4"

Velleman Projects
 all about the Velleman van
 developments: Kits, Modules,
 Instruments and Home Automation

Search product

Search Product

Navigation

- Home page
- Products
- Sales outlets
- Support
- Publications
- Jobs
- About us

News

NEW HI-ZERO LED CUBE
 SUBVERSIVE software
 software for download
 here!

Posted on 2014-12-12
 Read more...

Velleman Projects Newsletter

Are you an electronics enthusiast or simply interested in our kits, modules, modules and instruments?

Subscribe to our newsletter and receive every month the latest news, new products & updates on Velleman Projects.

You will receive an email. Click on the link in that email to confirm your subscription.

Email Submit

Advertisement links:
 velleman.eu
 support.velleman.eu
 gmail.eu
 vellemanprojects.eu
 velleman.eu
 forum.velleman.eu

Advertisements

ADVERTISEMENT VELLEMAN
 Android Application



Subscribing our newsletter?, visit www.vellemanprojects.eu

velleman projects

JUST PUBLISH IT!
 Publish your idea
 vellemanprojects.eu

Support Forum (EN/DE)
 vellemanprojects.eu

Support Forum (EN/DE)

Home | Register | Login | Help | Search

Monday, October 24, 2015 1:05 pm

28 Topics, 212

Author	Topic	Replies	Views	Last post
Velleman Projects - Support Forum	Velleman Projects - Support Forum	2	3	Wed Sep 16, 2015 12:04 pm vvelleman
Velleman Projects - Support Forum	Velleman Projects Forum - Questions	1	4	Thu Sep 17, 2015 12:21 pm vvelleman
Velleman Projects - Support Forum	Velleman Projects Forum - Questions			
Velleman Projects - Support Forum	Velleman Projects Forum - Questions	404	2172	Fri Sep 11, 2015 12:01 pm vvelleman
Velleman Projects - Support Forum	Velleman Projects Forum - Questions			
Velleman Projects - Support Forum	Velleman Projects Forum - Questions	102	420	Wed Sep 16, 2015 12:07 pm vvelleman
Velleman Projects - Support Forum	Velleman Projects Forum - Questions	201	1202	Fri Sep 11, 2015 12:01 pm vvelleman
Velleman Projects - Support Forum	Velleman Projects Forum - Questions	1150	6140	Fri Sep 11, 2015 12:01 pm vvelleman
Velleman Projects - Support Forum	Velleman Projects Forum - Questions	427	2146	Fri Sep 11, 2015 12:01 pm vvelleman
Velleman Projects - Support Forum	Velleman Projects Forum - Questions	320	166	Fri Sep 11, 2015 12:01 pm vvelleman
Velleman Projects - Support Forum	Velleman Projects Forum - Questions	636	3220	Fri Sep 11, 2015 12:01 pm vvelleman

Participate our Velleman Projects Forum



Participate our Velleman Projects Forum



Velleman N.V.
Legen Heirweg 33
9890 Gavere
(België)

assembly hints

1. Assembly (Skipping this can lead to troubles !)

Ok, so we have your attention. These hints will help you to make this project successful. Read them carefully.

1.1 Make sure you have the right tools:

- A good quality soldering iron (25-40W) with a small tip.
- Wipe it often on a wet sponge or cloth, to keep it clean; then apply solder to the tip, to give it a wet look. This is called 'thinning' and will protect the tip, and enables you to make good connections. When solder rolls off the tip, it needs cleaning.
- Thin raisin-core solder. Do not use any flux or grease.
- A diagonal cutter to trim excess wires. To avoid injury when cutting excess leads, hold the lead so they cannot fly towards the eyes.
- Needle nose pliers, for bending leads, or to hold components in place.
- Small blade and Phillips screwdrivers. A basic range is fine.

For some projects, a basic multi-meter is required, or might be handy.

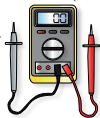

1.2 Assembly Hints :

- Make sure the skill level matches your experience, to avoid disappointments.
- Follow the instructions carefully. Read and understand the entire step before you perform each operation.
- Perform the assembly in the correct order as stated in this manual.
- Position all parts on the PCB (Printed Circuit Board) as shown on the drawings.
- Values on the circuit diagram are subject to changes, the values in this assembly guide are correct*.
- Use the check-boxes to mark your progress.
- Please read the included information on safety and customer service.

* Typographical inaccuracies excluded. Always look for possible last minute manual updates, indicated as 'NOTE' on a separate leaflet.

1.3 Soldering Hints :

1. Mount the component against the PCB surface and carefully solder the leads. →

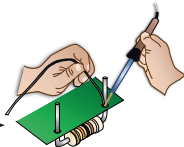

2. Make sure the solder joints are cone-shaped and shiny. →



3. Trim excess leads as close as possible to the solder joint. →



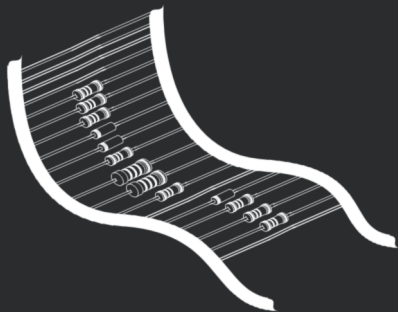

REMOVE THEM FROM THE TAPE ONE AT A TIME !

Included in
this kit

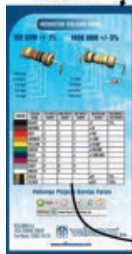

2. RESISTOR

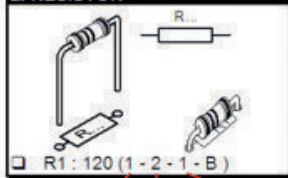

COLOUR	COLOUR NAME	1ST DIGIT/ STRIPE	2ND DIGIT/ STRIPE	3RD DIGIT/ STRIPE	MULTIPLIER STRIPE	TOL 4TH!
Black	BLACK	0	0	0	x1	1%
Brown	BROWN	1	1	1	x10	
Red	RED	2	2	2	x100	
Orange	ORANGE	3	3	3	x1.000	
Yellow	YELLOW	4	4	4	x10.000	
Green	GREEN	5	5	5	x100.000	
Blue	BLUE	6	6	6	x1.000.000	

DO NOT BLINDLY FOLLOW THE ORDER OF THE COMPONENTS ONTO THE TAPE. ALWAYS CHECK THEIR VALUE ON THE PARTS LIST!

I CONSTRUCTION

1 Diac

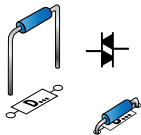

2 Resistors

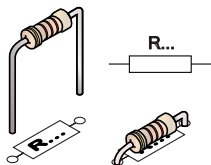

□ R1: 5K6 (5 - 6 - 2 - B)

FOR 110/125V ONLY:

□ R2: 220K (2 - 2 - 4 - B)

3 Potentiometer

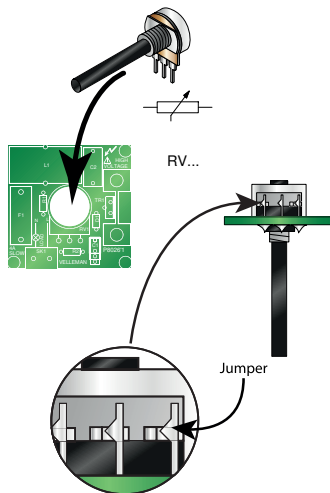

□ RV1: 470K

Use supplied jumper wire to connect as shown.

4 Ceramic capacitors

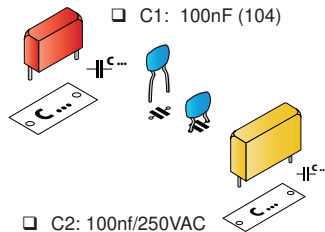

□ C1: 100nF (104)

□ C2: 100nf/250VAC

5 Terminal block



□ SK1: 2p

6 Fuse holder + Fuse

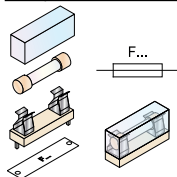

□ F1 (4AT)

7 Coil

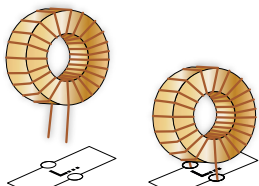

□ L1: 1,5mH / 1KHz. - 4A

8 Triac

10mm M3 bolt

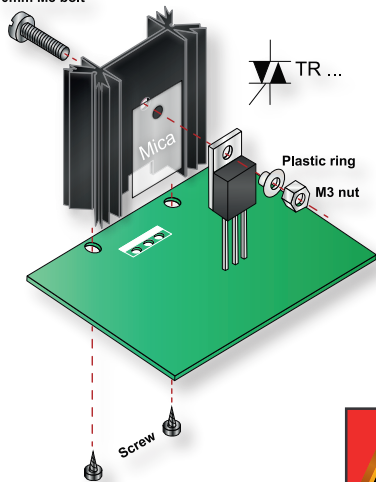

□ TR1: TIC225M or eq.

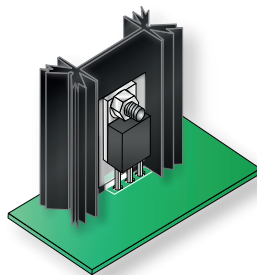

IMPORTANT : Put an extra layer of solder on all pre-thinned PCB tracks, to improve their current handling capabilities.

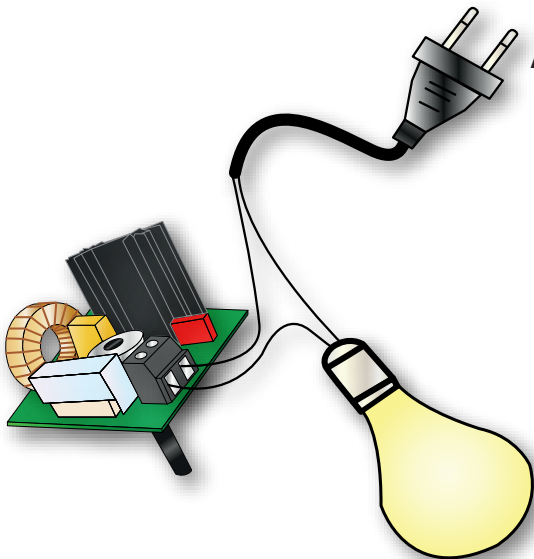
II HOOK-UP EXAMPLE**AC POWER**

WARNING : All parts carry lethal voltages!
Do not touch while operating. Use an isolated enclosure knob.

MAXIMUM:
380W / 110V
750W / 240V

DANGER !**Observe all safety requirements !**

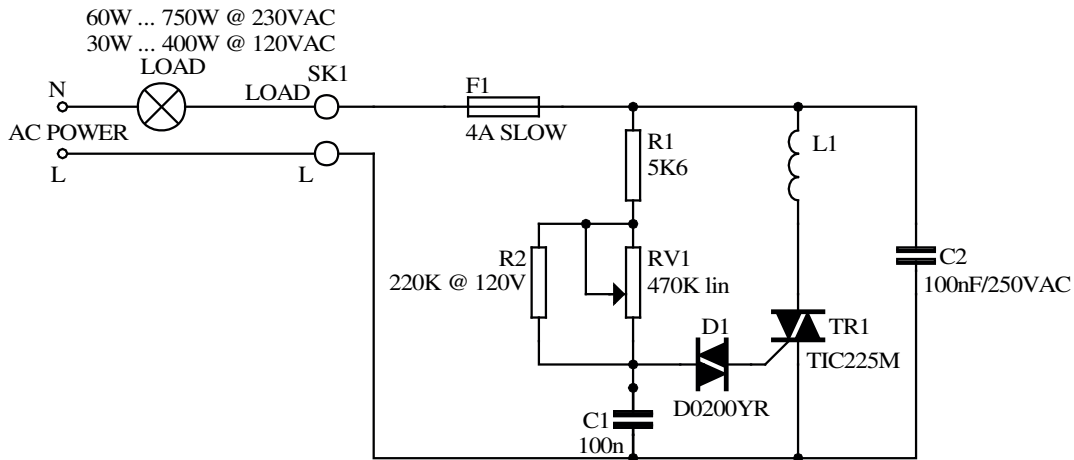

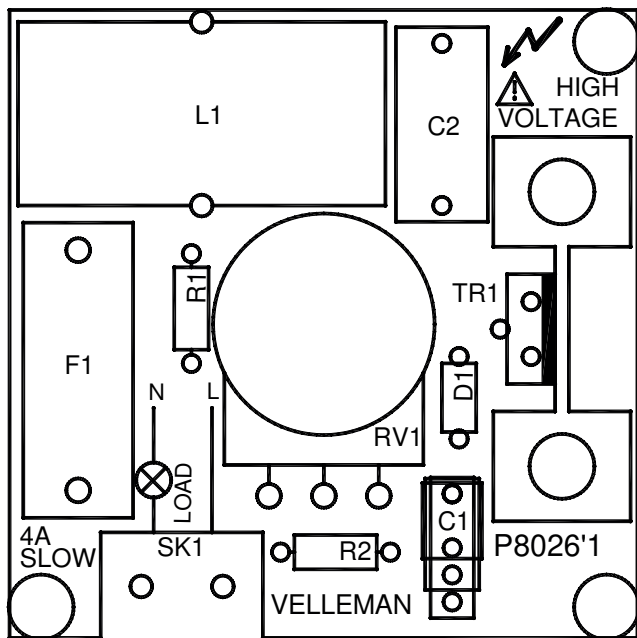

Leds and how to use them

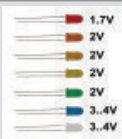

Leds feature a specific voltage drop, depending on type and colour. Check the datasheet for exact voltage drop and rated current !

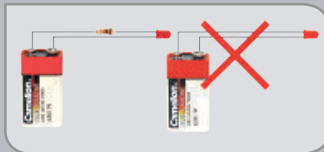
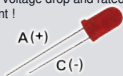

Never connect leds in parallel

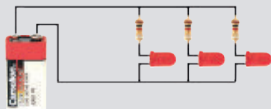
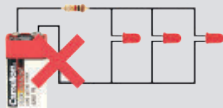

How to Calculate the series resistor:

Example: operate a red led (1.7V) on a 9Vdc source.

Required led current for full brightness: 5mA (this can be found in the datasheet of the led)

$$\frac{\text{Supply voltage (V) - led voltage (V)}}{\text{required current (A)}} = \text{series resistance (ohms)}$$



$$\frac{9V - 1.7V}{0.005A} = 1460 \text{ ohm}$$

closest value :
use a 1k5 resistor

Required resistor power handling=
voltage over resistor x current passed trough resistor



$$(9V - 1.7V) \times 0.005A = 0.036W$$

a standard 1/4W resistor
will do the job

LEDs in series:

Example: 3 x red led (1.7V) on 9V battery
Required led current for full brightness: 5mA
(this can be found in the datasheet of the led)

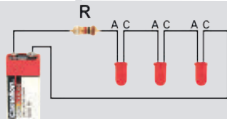

$$\frac{\text{Supply voltage (V) - (number of leds x led voltage (V))}}{\text{required current (A)}} = \text{series resistance (ohms)}$$



$$\frac{9V - (3 \times 1.7V)}{0.005A} = 780 \text{ ohm}$$

use an
820 ohm resistor

open collector outputs

An open collector output can be compared to a switch which switches to ground when operated

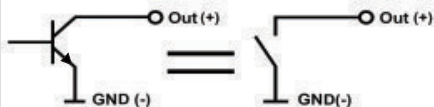

Example: How to switch an LED by means of an open collector output

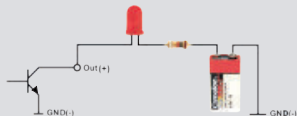



The new Velleman Projects catalogue is
now available. Download your copy here:

www.vellemanprojects.eu

 @velleman_RnD



Modifications and typographical errors reserved - © Velleman nv. H8026IP'1 (rev.1)
Velleman NV, Legen Heirweg 33 - 9890 Gavere.