

# STROBOSCOPE

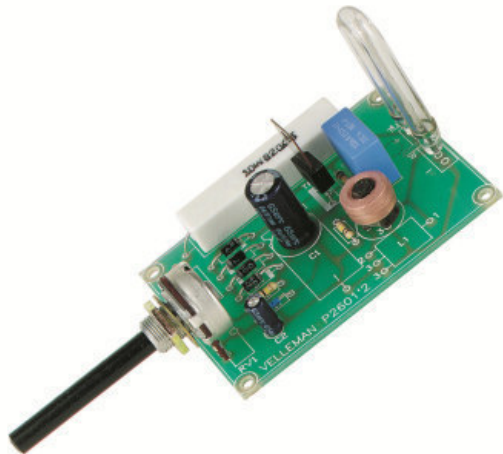

## K2601

Great for party's, stage, photography, ...

### Features

- Power supply : 220-240VAC
- Power consumption : 3-10W
- Flash frequency : 2-20Hz
- Nominal flash energy : 11Ws
- Life-time : typical 800.000 flashes



**VELLEMAN NV**

**Legen Heirweg 33**

**9890 Gavere**

**Belgium Europe**

**[www.velleman.be](http://www.velleman.be)**

**[www.velleman-kit.com](http://www.velleman-kit.com)**

## Features

- Dynamic effect for disco's and party's
- Imitate lightning strikes - great for theatrical productions
- Photographic special effects
- Use as warning or hazard light
- Great to attract attention !
- Your own unique application

## Specifications

- Power supply : 220-240VAC
- Power consumption : 3-10W
- Flash frequency : 2-20Hz
- Nominal flash energy : 11Ws
- Life-time : typical 800.000 flashes
- Dimensions : 86x65x45 mm / 3.4"x2.6"x1.8"

### 1. Assembly (Skipping this can lead to troubles !)

Ok, so we have your attention. These hints will help you to make this project successful. Read them carefully.

#### 1.1 Make sure you have the right tools:

- A good quality soldering iron (25-40W) with a small tip.
- Wipe it often on a wet sponge or cloth, to keep it clean; then apply solder to the tip, to give it a wet look. This is called 'thinning' and will protect the tip, and enables you to make good connections. When solder rolls off the tip, it needs cleaning.
- Thin raisin-core solder. Do not use any flux or grease.
- A diagonal cutter to trim excess wires. To avoid injury when cutting excess leads, hold the lead so they cannot fly towards the eyes.
- Needle nose pliers, for bending leads, or to hold components in place.
- Small blade and Phillips screwdrivers. A basic range is fine.

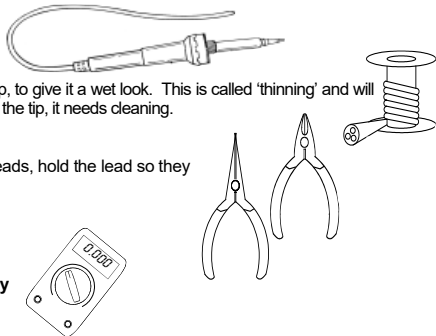

**For some projects, a basic multi-meter is required, or might be handy**

#### 1.2 Assembly Hints :

- ⇒ Make sure the skill level matches your experience, to avoid disappointments.
  - ⇒ Follow the instructions carefully. Read and understand the entire step before you perform each operation.
  - ⇒ Perform the assembly in the correct order as stated in this manual
  - ⇒ Position all parts on the PCB (Printed Circuit Board) as shown on the drawings.
  - ⇒ Values on the circuit diagram are subject to changes.
  - ⇒ Values in this assembly guide are correct\*
  - ⇒ Use the check-boxes to mark your progress.
  - ⇒ Please read the included information on safety and customer service
- \* Typographical inaccuracies excluded. Always look for possible last minute manual updates, indicated as 'NOTE' on a separate leaflet.

**1.3 Soldering Hints :**

1- Mount the component against the PCB surface and carefully solder the leads

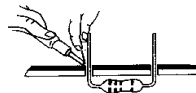

2- Make sure the solder joints are cone-shaped and shiny

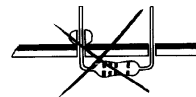
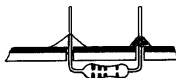

3- Trim excess leads as close as possible to the solder joint



**REMOVE THEM FROM THE TAPE ONE AT A TIME !**

**DO NOT BLINDLY FOLLOW THE ORDER OF THE COMPONENTS ON THE TAPE. ALWAYS CHECK THEIR VALUE ON THE PARTS LIST!**

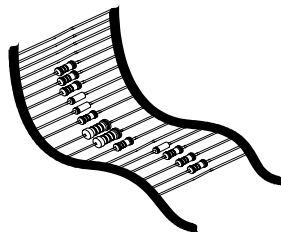

**1. Diac.**

DI1 : DO35

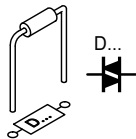
**2. Diodes. Watch the polarity !**

D1 : 1N4007  
 D2 : 1N4007  
 D3 : 1N4007  
 D4 : 1N4007

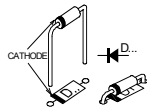
**3. Resistors**

R2 : 100K (1-0-4-B)  
 R3 : 100K (1-0-4-B)  
 R4 : 100K (1-0-4-B)

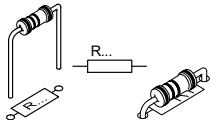
**4. PCB tabs**

J1 : N  
 J1 : L

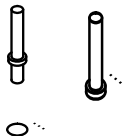
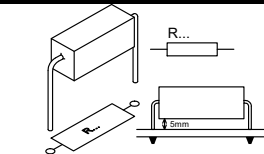
**5. 10W Resistor.**

R1 : 820

**6. Trigger coil**

L1

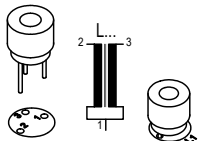
**7. Capacitor**

C3 : 100nF/250Vac

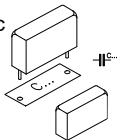
**8. Electrolytic Capacitors. Watch the polarity !**

C1 : 10µF/350V !!!  
 C2 : 10µF / 50V

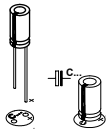
**9. Triac. Watch the position!**

TRI1 : TIC206M

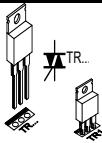

### 10. Potentiometer

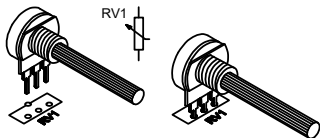

□ RV1 : 470K

### 11. Flash tube.

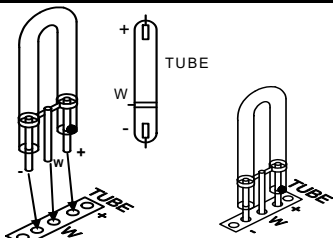

□ Tube

☞ Watch the position of the dot!

## 12. Connection example

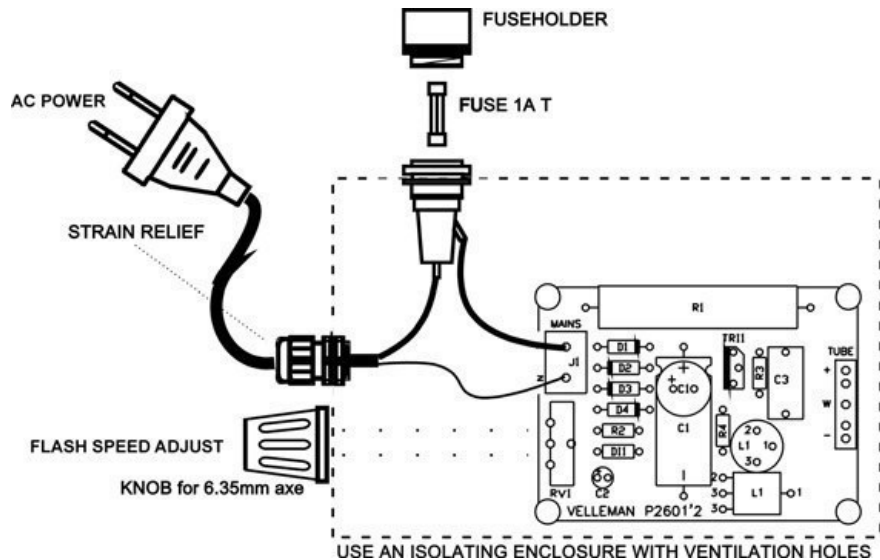



13. PCB

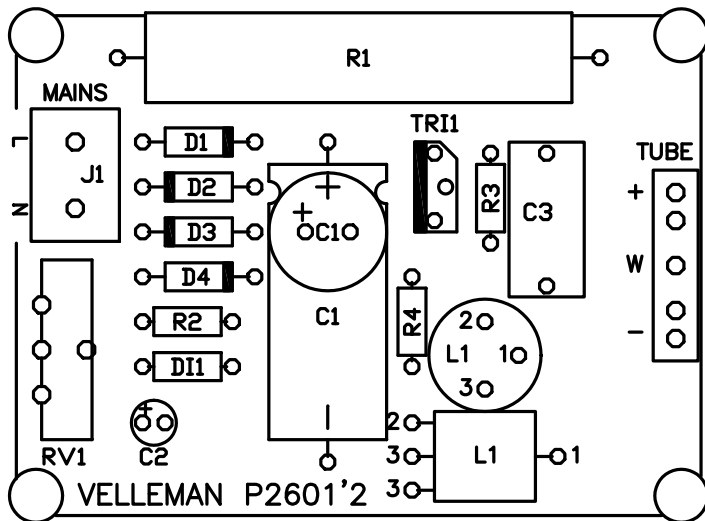

## 14. Diagram

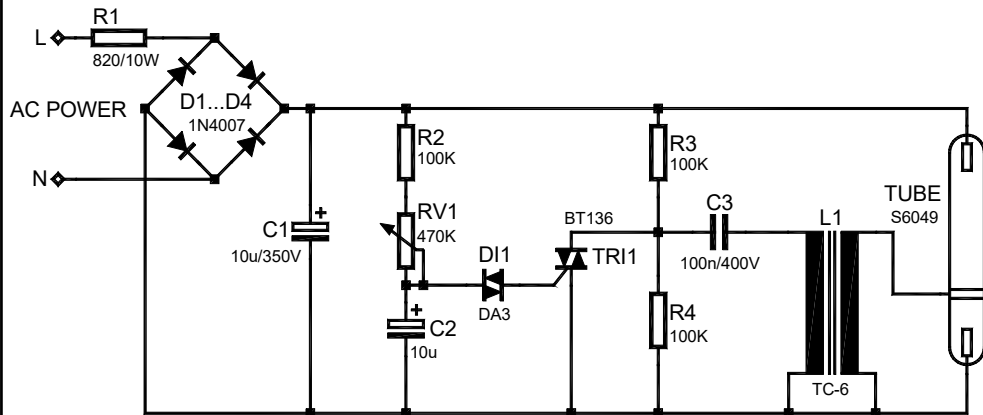





VELLEMAN NV  
Legen Heirweg 33, B-9890 GAVERE  
Belgium (Europe)

 @velleman\_RnD

